

# TAMRON

**SP150-600mm F/5-6.3 Di VC USD**  
(for Nikon, Canon)

**SP150-600mm F/5-6.3 Di USD**  
(for Sony \*Models without the VC)

Model: A011

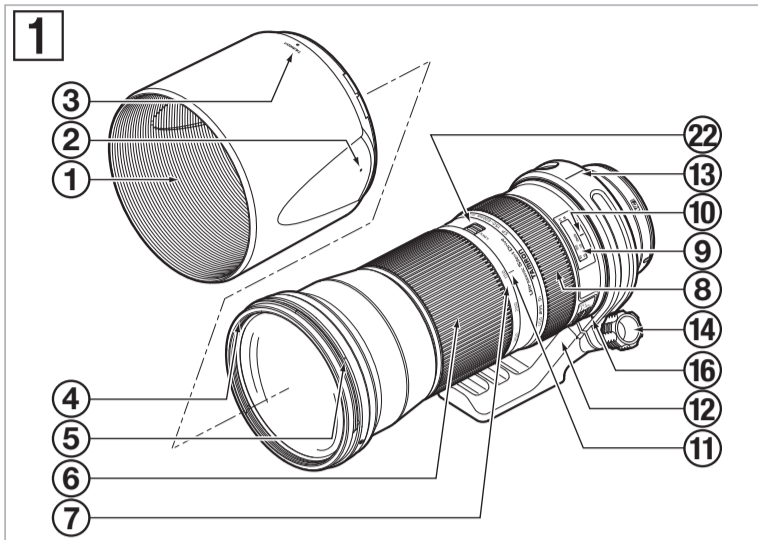

### Nikon

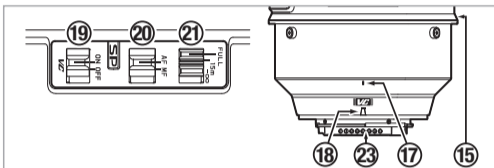

\* A011: This model is Built-in Motor

### Canon

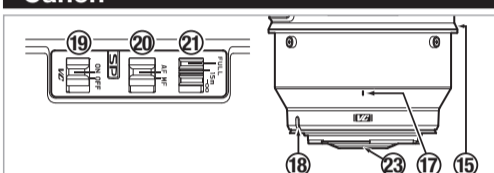

### Sony

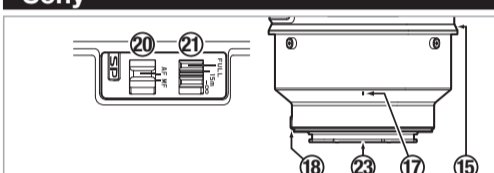

\* Common with the Konica Minolta α mount.

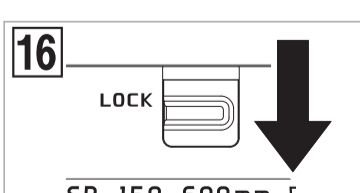
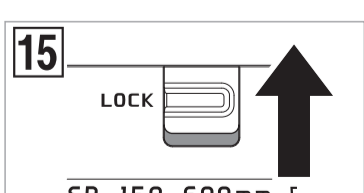
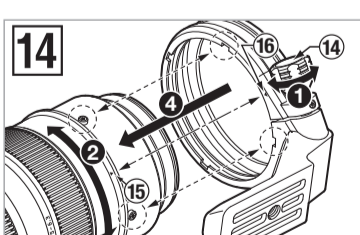
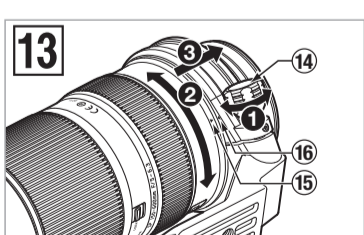
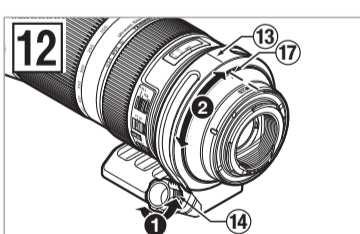
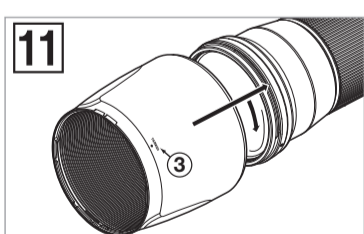
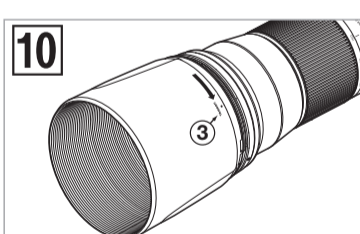
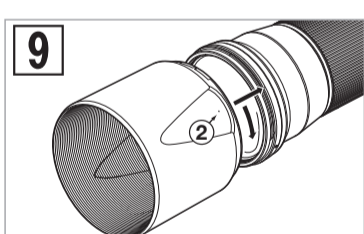
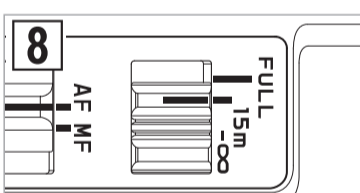
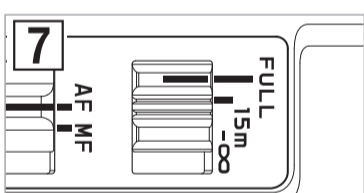
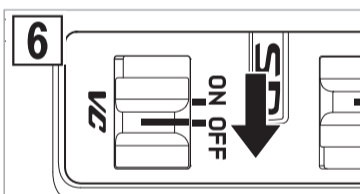
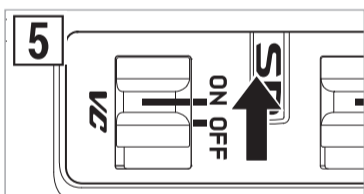
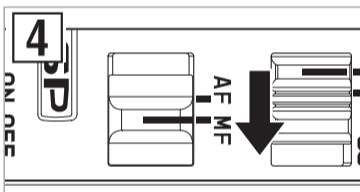
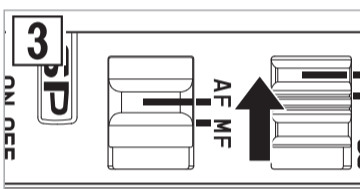
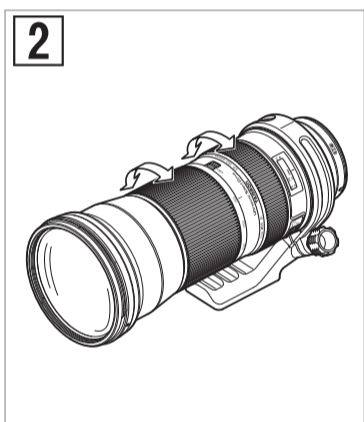

**CE** \* The CE Marking is a directive conformity mark of the European Community (EC).  
 \* Das CE-Zeichen entspricht der EC Norm.  
 \* La marca CE es marca de conformidad segun directiva de la Comunidad Europea (CE).  
 \* Il marchio CE attesta la conformita alla direttiva della Comunità Europea (CEE).  
 \* CE 标志表示符合欧州共同体(EC)指标

**CE** The EEC Conformity Report applies to the Council Directive 98/336/EEC, 92/31/EEC, 93/68/EEC and is used by Tamron Co., Ltd., manufacturer of this product.

